

# SG Control A

---

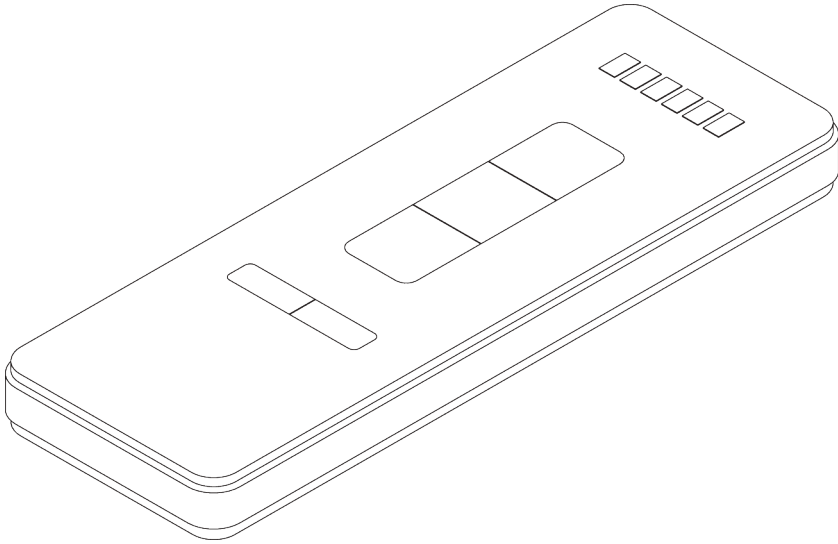

## PRODUCT INFORMATION

- *Radio controlled*
- *1-channel, 2-channel, 5-channel or 6-channel radio controls*
- *Radio hand held and wall controls*
- *Single and multi channel timer units*

# APPLICATION

## A. SYSTEMS

- Electric curtain track system SG 5100
- Roller blind system SG 4955
- Roman blind system SG 2345

# OVERVIEW COMPONENTS

## A. RADIO CONTROLS

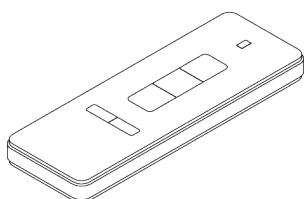

### **SG 10946**

- **Channel:** 1 channel
- **Frequency:** 433.92 MHz
- **Colours:** white

#### **Features:**

- Operates single system or operates one group of systems

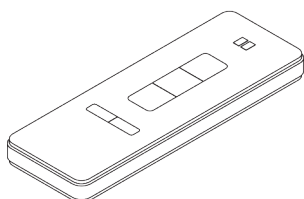

### **SG 10947**

- **Channel:** 2+1 channel
- **Frequency:** 433.92 MHz
- **Colours:** white

#### **Features:**

- 2 channel: operates up to two single systems individually
- 2 channel: operates up to two groups of systems individually
- 1 channel: operates all systems together

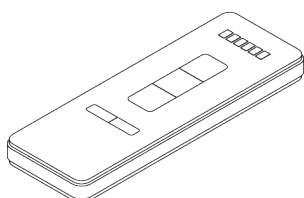

### **SG 10948**

- **Channel:** 6+1 channel
- **Frequency:** 433.92 MHz
- **Colours:** white

#### **Features:**

- 6 channel: operates up to 6 single systems individually
- 6 channel: operates up to 6 groups of systems individually
- 1 channel: operates all systems together

## B. RADIO WALL CONTROLS

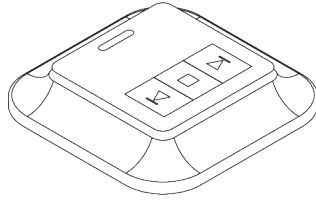

### **SG 10949**

- **Channel:** 1 channel
- **Frequency:** 433.92 MHz
- **Colours:** white

#### **Features:**

- Operates single system or operates one group of systems

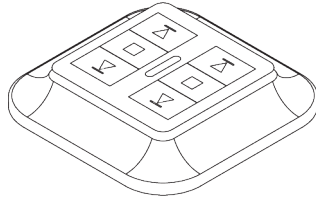

### **SG 10950**

- **Channel:** 2 channel
- **Frequency:** 433.92 MHz
- **Colours:** white

#### **Features:**

- 2 channel: operates up to two single systems individually
- 2 channel: operates up to two groups of systems individually

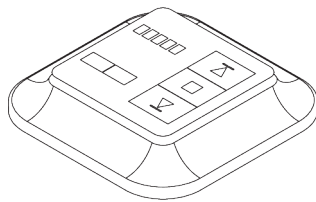

### **SG 10951**

- **Channel:** 5+1 channel
- **Frequency:** 433.92 MHz
- **Colours:** white

#### **Features:**

- 5 channel: operates up to 5 single systems individually
- 5 channel: operates up to 5 groups of systems individually
- 1 channel: operates all systems together

## C. RADIO TIMER UNITS

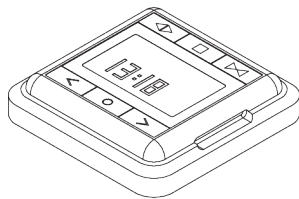

### **SG 11429**

- **Channel:** 1 channel
- **Frequency:** 433.92 MHz
- **Colours:** white

#### **Features:**

- Operates single system
- Operates one group of systems
- LCD display
- Touch button control
- Single 'open' and 'close' time setting

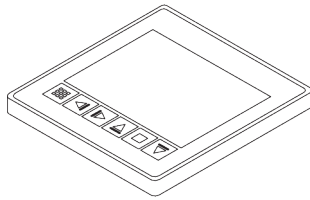

**SG 11093**

- **Channel:** 16 channel
- **Frequency:** 433.92 MHz
- **Colours:** white

**Features:**

- 16 channel: operates up to 16 single systems individually
- 16 channel: operates up to 16 groups of systems individually
- LCD display
- Touch button control
- Timing function with max. 8 timing points programmable for daily and weekly cycles

**D. MANUALS**

Refer to Silent Gliss website.

# COMBINATION CONTROLS AND SYSTEMS

**A. EXAMPLE**

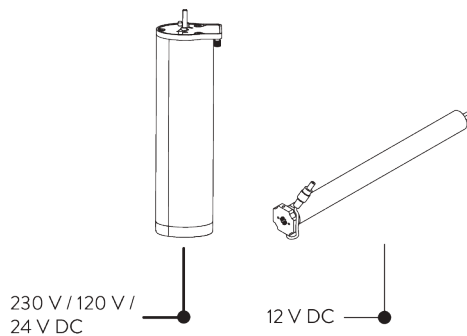

Applicable with following systems:

- Electric curtain track system SG 5100
- Roller blind system SG 4955
- Roman blind system SG 2345

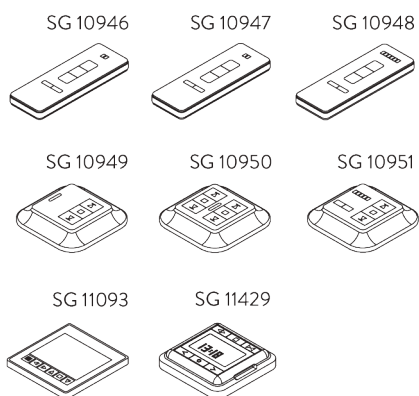

**B. WIRING DIAGRAMS**



Refer to Silent Gliss website.

# PARTS

## A. CONTROLS



**SG 10946**

*Radio hand held 1 channel*



**SG 10947**

*Radio hand held 2+1 channel*



**SG 10948**

*Radio hand held 6+1 channel*



**SG 10949**

*Radio wall transmitter 1 channel*



**SG 10950**

*Radio wall transmitter 2 channel*

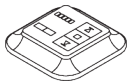

**SG 10951**

*Radio wall transmitter 5+1 channel*

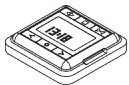

**SG 11429**

*Radio timer unit 1 channel*





